

SPECIFICATIONS



Model Number: SD12K1
Part Number: 17000003A

Rev: 00
Sep. 18, 2017

Mechanical Drawing:

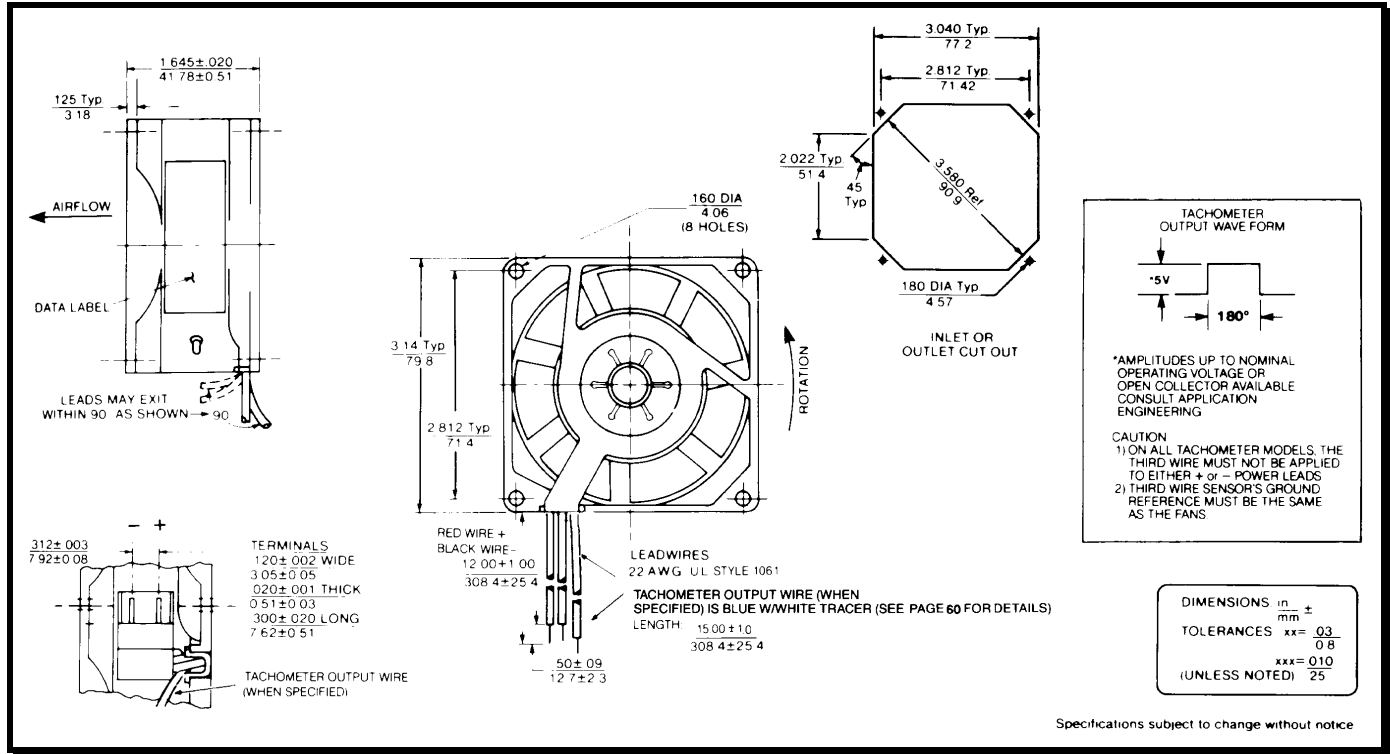

Motor:

Nominal Voltage = 12 vdc
 Operating Voltage Range = 6 – 14 vdc
 Nominal Running Current = 0.43 amps
 Locked Rotor Current = 1.0amps
 Running Power = 5.2watts
 Average Speed = 4200
 Bearings = Ball
 Air Flow = 43 CFM
 Acoustic = 52.1 dBA

Construction:

Venturi: Die-Cast Aluminum, Black
 Propeller: Plastic, Black, UL 94V-0

Life Expectancy:

This fan is designed for continuous duty life of 83,000 hours at 40°C.

Additional Features:

Brushless DC Motor
 Locked Rotor Protection
 Polarity Protected
 Automatic Restart Capability
 Operating Temperature: -10°C to 70°C
 Storage Temperature: -40°C to 85°C

Termination:

12" Lead wires, AWG 22, UL 1061
 Red = Power (+)
 Black = Return (-)

Agency Approvals:

UL, CUL, CE

PQ Curve:

