

# SPECIFICATIONS



**Model Number:** SD12K1  
**Part Number:** 17000003A

**Rev:** 00  
**Sep.** 18, 2017

## Mechanical Drawing:

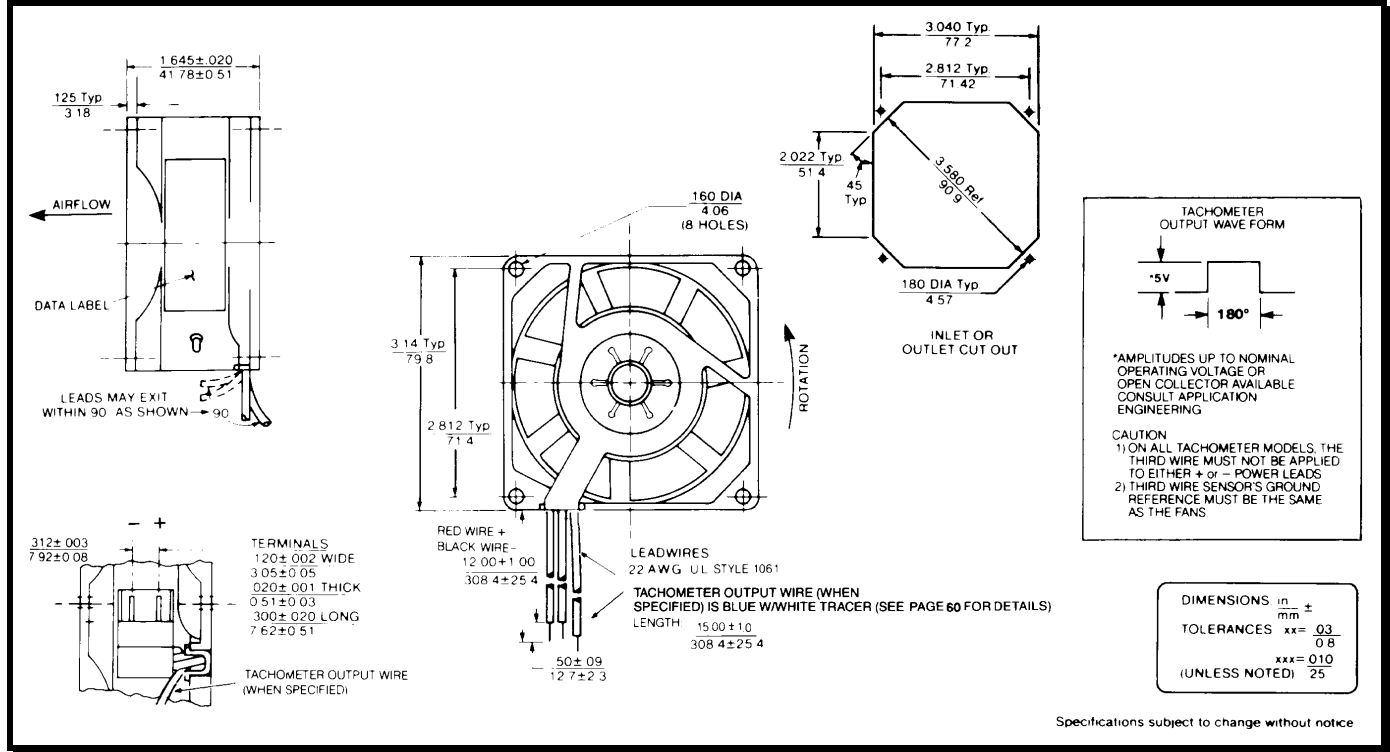

### Motor:

Nominal Voltage = 12 vdc  
 Operating Voltage Range = 6 – 14 vdc  
 Nominal Running Current = 0.43 amps  
 Locked Rotor Current = 1.0amps  
 Running Power = 5.2watts  
 Average Speed = 4200  
 Bearings = Ball  
 Air Flow = 43 CFM  
 Acoustic = 52.1 dBA

### Construction:

Venturi: Die-Cast Aluminum, Black  
 Propeller: Plastic, Black, UL 94V-0

### Life Expectancy:

This fan is designed for continuous duty life of 83,000 hours at 40°C.

### Additional Features:

Brushless DC Motor  
 Locked Rotor Protection  
 Polarity Protected  
 Automatic Restart Capability  
 Operating Temperature: -10°C to 70°C  
 Storage Temperature: -40°C to 85°C

### Termination:

12" Lead wires, AWG 22, UL 1061  
 Red = Power (+)  
 Black = Return (-)

### Agency Approvals:

UL, CUL, CE

**PQ Curve:**

